

**UH044DP
DELUXE PACK**
Operating Guide



Uniden



UNIDEN Model UH044DP DELUXE PACK UHF CB Radio

WARNING!



The citizen band radio service is licenced in Australia by ACMA Radio-communications (Citizen Band Radio Stations) Class Licence and in New Zealand by MED General User Licence for Citizen Band Radio and operation is subject to conditions contained in those licenses.



UNIDEN Model UH044DP DELUXE PACK UHF CB Radio

CONTENTS

Introduction	
Features	3
Controls & Indicators	4
Included in Your UH044DP DELUXE PACK	6
Getting Started	
Battery Installation	7
Charging Batteries	8
Battery Level Display	9
Low Battery Alert	10
Wrist Strap	10
Operation	
Power On/Off	11
Volume	11
Selecting a Channel	12
To Transmit and Receive	12
To Operate in Duplex Mode	13
Transmit Power Select	14
Scanning	15
1. Open Scan Mode	15
2. Group Scan Mode	16
Priority Channel	17
Programming Scan Channels	17
Drop-Out Delay	18
Keypad Confirmation Tone	18
Power Save	18
Back Lighting	19
Keypad Lock	19
Monitor	19
UHF CB Channels & Frequencies	20
Warranty	22



UNIDEN Model UH044DP DELUXE PACK UHF CB Radio

INTRODUCTION

The UH044DP DELUXE PACK contains the UH044 portable two-way UHF-CB radio. It is compact, rugged and fits easily in your hand. This hand held UHF radio will give you consistent, outstanding performance in virtually all conditions and situations. To ensure that you get the most from the UHO44's features, please read this operating guide carefully before using the unit.

FEATURES

- 40 Channels
- Switchable Output Power 2W/0.5W/0.04W
- Up to 8 km range*
- LCD Display
- Group Scan with Priority Channel Watch
- Open Scan
- Duplex Capability
- Monitor
- LCD Back Light (Auto On for 5 Sec)
- Auto Power Save
- Battery Level Indicator
- Keypad Lock
- Key Touch Tone On/Off
- Auto Squelch Control

**Range varies depending on the environment. 8km range is noted in a flat open environment.*



UNIDEN Model UH044DP DELUXE PACK UHF CB Radio

CONTROLS & INDICATORS

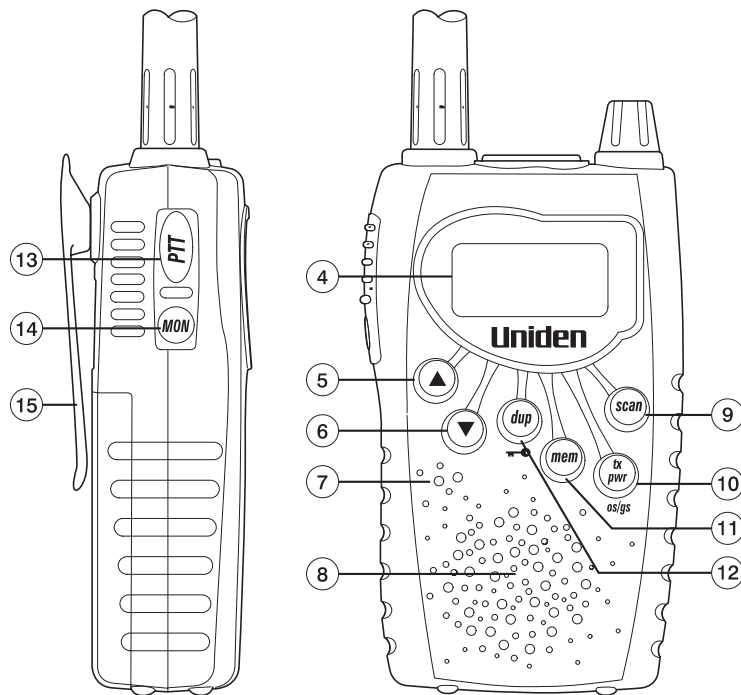
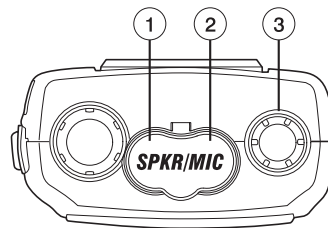

UNIDEN Model UH044DP DELUXE PACK UHF CB Radio

CONTROLS & INDICATORS

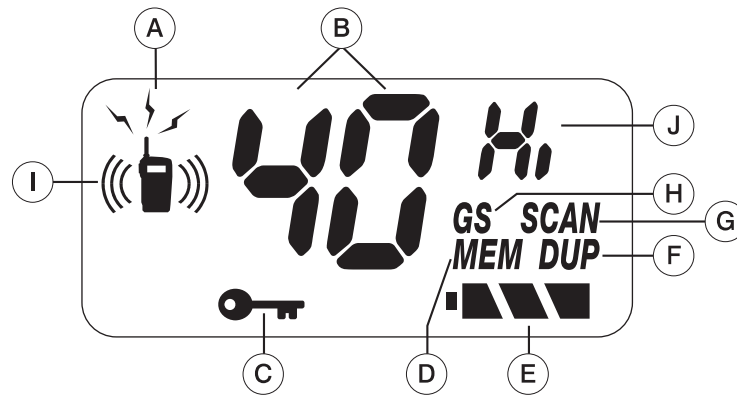

- A. Transmit
- B. Channel Numbers
- C. Key Lock
- D. Memory
- E. Battery Level Indicator
- F. Duplex Transmit

- G. Scanning
- H. Group Scanning
- I. Receiving
- J. Power Level Indicator

-
- 1. Speaker Jack
 - 2. Microphone Jack
 - 3. On/Off Volume
 - 4. LCD Display
 - 5. Up Button
 - 6. Down Button
 - 7. Microphone
 - 8. Speaker
 - 9. Scan Button
 - 10. Transmit Power Select / open/group scan
 - 11. Memory On/Off Button
 - 12. Duplex On/Off Button
 - 13. PTT (Push-to-talk) Button
 - 14. Monitor Switch
 - 15. Belt Clip



UNIDEN Model UH044DP DELUXE PACK UHF CB Radio

INCLUDED IN YOUR UH044DP DELUXE PACK



UH-044



Wrist Strap

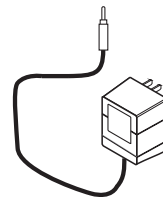

AC Adaptor

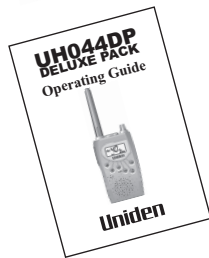

Operating Guide

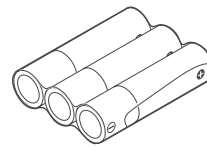

3x AA NiCd batteries



If any of these items are missing from the box, contact your Uniden Dealer.

Optional Accessories

- Speaker Microphone (SM-040)
- Earpiece/Microphone (EM-044)
- Additional AC Adaptor (AAD-044S)
- Cigarette Charger (CL-040)
- Headset Microphone (HM-040)



GETTING STARTED

BATTERY INSTALLATION

Your Deluxe pack includes 3 AA rechargeable NiCd batteries to power the UH044. You must install and then charge the batteries for 15-20 hrs before use. The UH044 can also use 3 AA Alkaline batteries.



Do not mix old and new batteries to avoid damage to the unit.

To install the batteries:

1. Make sure your radio is off.
2. Release the battery cover clip, then remove the battery cover.

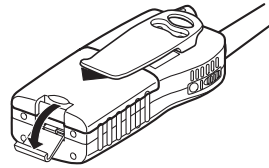

3. Insert 3 AA rechargeable NiCd batteries according to the polarity symbols inside the battery compartment.

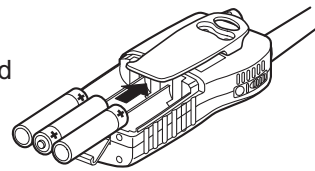

4. Align the battery cover tabs with the UH044 tab holes then replace the cover.

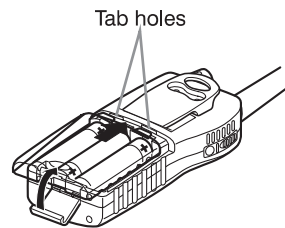

GETTING STARTED

CHARGING BATTERIES



Warning Notice! Use only the supplied AAD-044S power adaptor if rechargeable batteries will be used in the UH044.

- Turn the UH044 knob **[ON/OFF VOLUME]** off and connect the AC adaptor plug to the mic jack.
- Battery charging times vary. A longer time is required to charge higher capacity batteries.

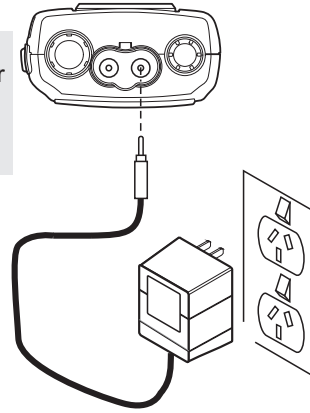

Rechargeable Batteries	Charging Time
700mAH Ni-Cad	14-16 hrs
1000mAH Ni-Cad	24-27 hrs
1300mAH Ni-MH	31-35 hrs

- Disconnect the AC adaptor from the unit when charging is completed.

BATTERY LIFE

Battery Type	Transmit Level	Battery Life
Alkaline	TX High	15 Hours
	TX Mid	25 Hours
	TX Low	42 Hours
NiCAD (700mA)	TX High	8 Hours
	TX Mid	10 Hours
	TX Low	15 Hours
NiMH (1700mA)	TX High	11 Hours
	TX Mid	18 Hours
	TX Low	35 Hours

GETTING STARTED

BATTERY LEVEL DISPLAY

The  icon in the bottom right hand corner of the screen indicates the UH044 current battery voltage level at all times. The battery level is displayed in 3 levels:

LEVEL 1
Battery 100% full



LEVEL 2
Battery approx
70% capacity



LEVEL 3
Battery approx
30% capacity



Almost Empty



When  SW is pressed at Level Empty, battery icon and channel number will flash.

GETTING STARTED

LOW BATTERY ALERT

The LCD on your radio shows a battery meter in the lower right corner.

- ■ ■ ■ icon indicates a fully powered unit. As the batteries lose power, ■ ■ ■ ■ will flash.



When the batteries in the unit are low, the unit will go into a Battery Low Mode.

The Transmit Mode is disabled.

Recharge the NiCd batteries or replace the Alkaline batteries immediately to continue using the radio.

WRIST STRAP

1. Insert short end of the strap through the belt clip hole.

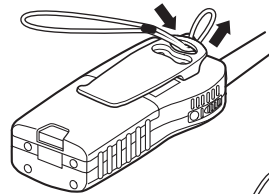

2. Slip the long end through the loop to enclose the clip in the strap and pull tight.

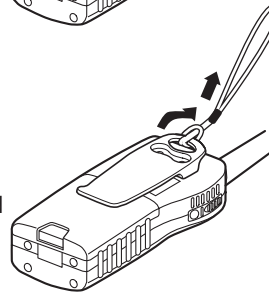

OPERATION

- See the Controls & Indicators pages 4 and 5 for button and key operations.
- When you press any key (except PTT), a short tone sounds.

POWER ON/OFF

To turn the unit **ON**, rotate the **[ON/OFF VOLUME]** clockwise until a “click” is heard. A channel number and battery level should appear on the display.



To turn the unit **OFF**, rotate the **[ON/OFF VOLUME]** knob counter-clockwise until a “click” is heard. The display will disappear.

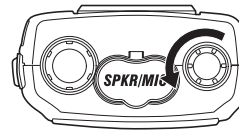

VOLUME

Turn the **[ON/OFF VOLUME]** control clockwise to increase the volume, counter-clockwise to decrease the volume.

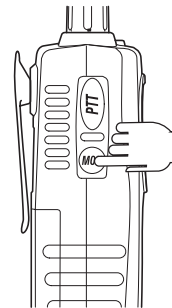

OPERATION

SELECTING A CHANNEL

Press ▲ or ▼ to select the desired channel.



If you press and hold the ▲ or ▼ channel numbers will scroll rapidly.

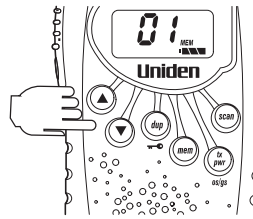

TO TRANSMIT AND RECEIVE

The UH044 uses the 40 UHF-CB Channels. For your reference a list of the available channels and corresponding frequencies is printed on page 20. (Channels 22 and 23 are for telemetry and telecommand applications. Transmit should be avoided on these channels).

1. The maximum RF transmit power of UH044 is 2 Watts.
2. Before you transmit, listen for activity on the selected channel.
3. When the channel is clear, press and hold the PTT to transmit.
 appears on the LCD.

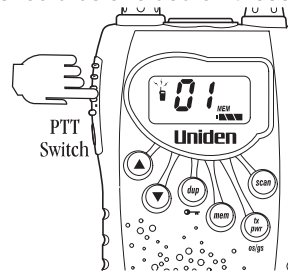

Hold the radio with microphone approximately 5 cm in front of your mouth with the antenna at approximately 45° angle away from your head. Speak in a clear, normal conversational voice.

4. When you have finished speaking, release the PTT and listen for a response then  disappears on the LCD.



 appears while receiving a signal.

OPERATION

TO OPERATE IN DUPLEX MODE (REPEATERS)

The Duplex function enables you to access local repeater stations.



You can only activate Duplex on CH01-CH08.

UHF CB Repeaters are used to retransmit or relay your signal. Repeaters will extend the range of your radio and overcome the shielding effect caused by solid obstructions.

Eg. CH01 is being used in your area for repeater use.

Press  momentarily. The

DUP icon appears.

Press  again to deactivate the duplex operation.

UH044 will return to simplex operation.



Contact your retailer for a list of repeaters available in your area.

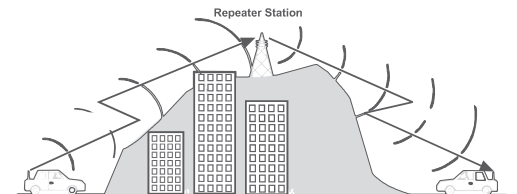

Operation with the aid of a Repeater



OPERATION

TRANSMIT POWER SELECT

The UH044 has three transmit power levels: 2 watt, 0.5 watt and 0.04 watts. To change your transmit power level:

1. Press  while in the 'power middle level' to change to 'power high level.'
2. Press  while in the 'power high level' to change to the 'power low level.'
3. Press  while in the 'power low level' to change to 'power middle level.'



TX Power Low

TX Power Middle

TX Power High



Transmitting on a higher level will use more Battery power but will enable you to transmit further.

OPERATION

SCANNING

The UH044 has two types of scanning; Open Scanning (OS) and Group Scanning (GS), OS Scan searches all the channels and frequencies in its memory continuously. GS Scan has the ability of monitoring a priority channel every 1.5 seconds while searching channels and frequencies in its memory.

Scanning allows you to search for active channels programmed in the OS or GS memory.



To initiate scanning,

1. Assuming the unit is on CH01 when switched on.
2. Press **(scan)** and scanning starts.
Scan icon flashes during scanning.

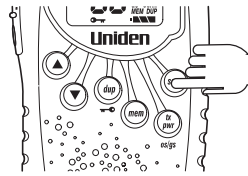

OPEN SCAN (OS) Mode (the absence of GS icon indicates that the unit is on OS mode)

Allows continuous scanning of channels stored in the Open Scan (OS) memory.

If an active channel is found, scanning will stop on that channel.



The factory has preprogrammed all the 40 UHF channels into the Open Scan channel memory. However, you can change or customise the channels by following the steps on programming Scan Channels on page 17.

Example. CH40 becomes active

If the received signal ceases, the unit will wait for at least 3 seconds for the signal to return, otherwise scanning resumes.



To skip the active channel, press **(mem)** momentarily. Scanning resumes.

To deactivate SCAN, press the **(scan)** or **(PTT)**.

OPERATION





1. If SCAN is deactivated while in an active channel, the UH044 will stay on that active channel. If no other channels are active, the UH044 will reinstate the starting channel.
2. If OS Scanning is initiated when there are no channels programmed in OS memory, an error tone will be heard and scanning will not start.
3. Press and hold  will switch to Group Scanning.

GROUP SCAN(GS) Mode

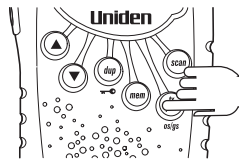
To use GS Mode Scanning, press and hold the  key. **GS** icon appears on the display.



1. When  is pressed during Group Scan Mode, icon will blink and Group Scan Scanning begins.
2. To deactivate GS scan, press  or .



1. If SCAN is deactivated while it is tuned to an active channel, the UH044 will stay on that active channel. If none of the channels re-active, the UH044 will reinstate the Priority channel.
2. If GS Scanning is initiated when there are no channels programmed in GS memory, an error tone will be heard and scanning will not start.
3. Press and hold  will switch to Open Scanning.



OPERATION

PRIORITY CHANNEL

The feature allows user to monitor one of the 40 channels, monitoring it every 1.5 secs during Group Scanning.

Choosing a Priority Channel

The starting channel, when scan is initiated, is always the Priority Channel. To change the priority channel setting while scanning, (eg. PRI Channel is CH17).

a. press  to select a higher channel (scanning pauses).



or

b. press , to select a lower channel (scanning pauses).





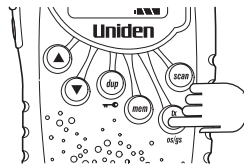

Programming Scan Channels

1. Select which Scanning Mode you wish to use on the channel OS or GS Mode.



OS is indicated by the absence of the GS icon.

2. Select the channel you want to store by pressing  or .
3. Press  to store. **MEM** icon appears.
4. To remove the channel from Memory, press  to remove. **MEM** icon disappears.

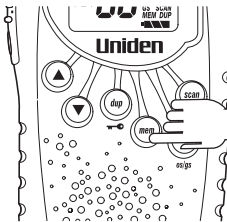

OPERATION

DROP-OUT DELAY

While scanning, the UH044 stops at a busy channel and receives a transmission. When the received signal is over, the unit will wait for 3 seconds for the return of the signal, otherwise, the radio resumes scanning.

KEYPAD CONFIRMATION TONE

Assures the user that the keypad has been properly pressed by emitting a beep tone. This tone can be switched on or off.

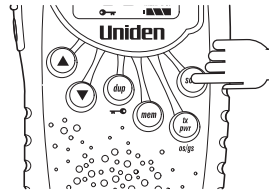

1. Press and hold  button for 1 sec "bp on" will appear for 1.5 secs and you will hear a beep sound.



2. Press and hold  button for 1 sec "bp of" will appear for 1.5 secs.



POWER SAVE

Battery Save feature extends the battery life by switching the receiver circuit power ON and OFF. This feature automatically activates during stand by mode (RX mode without signal). It turns OFF automatically when a signal is present, and activates again after channel inactivity.

OPERATION

BACK LIGHTING

The Liquid Crystal Display (LCD) is backlit for easy viewing at night or in low light situations. The back lighting automatically switches ON every time a key (except PTT) is pressed. It turns OFF 5 secs after the last key is pressed.

KEYPAD LOCK

To prevent accidental entries, you can lock the keypad. Press and hold the **(dup)** button for 1.5 Secs until it beeps to activate Key Lock.

 icon appears.

To unlock the keypad, press and hold **(dup)** the button again for 1.5 Secs.  icon disappears.



When the Key Lock is active, a warning beep will be heard if you attempt to press the keys.

MONITOR

This feature enables users to listen in for weak signals on the current channel at the press of a button.



To use monitor,

- For brief listening, press **(MON)**.
- For continuous listening, Press and hold **(MON)** for 2 sec. A two tone beep will be heard and the receiver circuit will stay open, letting in both the noise & weak signals.
- Display shows  icons.
- To return to normal receive mode press **(MON)**, **(scan)**, **(PTT)**, **(▲)** or **(▼)**.

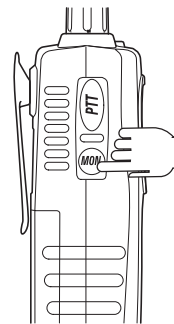

UHF CB CHANNELS & FREQUENCIES



Please follow these guidelines for channel use in Australia:

- Channels 05 and 35 are Emergency Channels.
- Channel 11 is a Calling Channel.
- Channels 22 and 23 are for telemetry and telecommand applications and TX should be avoided on these channels.

General communication is accepted on all other channels with these guidelines:

- Channel 40 - road channel (Australia).
- Channels 01-08 (and 31-38) are repeater channels.

CH No.	Simplex Mode Transmit / Receive Frequency (MHz)	Duplex Mode Transmit Frequency (MHz)	CH No.	Simplex Mode Transmit/Receive Frequency (Mhz)
1	476.425	477.175 CH31	21	476.925
2	476.450	477.200 CH32	22	476.950
3	476.475	477.225 CH33	23	476.975
4	476.500	477.250 CH34	24	477.000
5	476.525	477.275 CH35	25	477.025
6	476.550	477.300 CH36	26	477.050
7	476.575	477.325 CH37	27	477.075
8	476.600	477.350 CH38	28	477.100
9	476.625		29	477.125
10	476.650		30	477.150
11	476.675		31	477.175
12	476.700		32	477.200
13	476.725		33	477.225
14	476.750		34	477.250
15	476.775		35	477.275
16	476.800		36	477.300
17	476.825		37	477.325
18	476.850		38	477.350
19	476.875		39	477.375
20	476.900		40	477.400

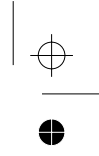
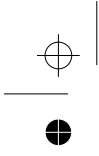

UNIDEN Model UH044DP DELUXE PACK UHF CB Radio

MEMO

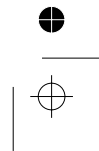
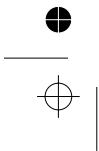

UNIDEN Model UH044DP DELUXE PACK UHF CB Radio

WARRANTY

UNIDEN UH044DP DELUXE PACK UHF CB Radio

Limited One Year Warranty



Please keep your sales docket as it provides evidence of warranty.

Warrantor: Uniden Australia Pty Limited ABN 58 001 865 498
Uniden New Zealand Limited

Warranty only available in original country of purchase

Elements of Warranty: Uniden warrants to the original retail owner for the duration of this warranty, its UH044 UHF CB Radio (hereinafter referred to as the Product) to be free from defects in materials and craftsmanship with only the limitations or exclusions set out below.

Warranty Duration: This warranty to the original retail owner only, shall terminate and be of no further effect ONE (1) Year after the date of original retail sale. This warranty will be deemed invalid if the product is; (A) Damaged or not maintained as reasonable and necessary, (B) Modified, altered or used as part of any conversion kits, subassemblies, or any configurations not sold by Uniden, (C) Improperly installed, (D) Repaired by someone other than an authorized Uniden Repair Agent for a defect or malfunction covered by this warranty, (E) Used in conjunction with any equipment or parts or as part of a system not manufactured by Uniden, (F) Installed, programmed or serviced by anyone other than an authorized Uniden Repair Agent, or (G) Where the Serial Number label of the product has been removed or damaged beyond recognition.

Parts Covered: This warranty covers for 1 year, the main unit only.

Accessories: Microphone, Power cord etc are covered for 90 days.

Statement of Remedy: In the event that the product does not conform to this warranty at any time while this warranty is in effect, the warrantor at its discretion, will repair the defect or replace the product and return it to you without charge for parts and service. THIS WARRANTY DOES NOT COVER OR PROVIDE FOR THE REIMBURSEMENT OR PAYMENT OF INCIDENTAL OR CONSEQUENTIAL DAMAGES. THIS GUARANTEE IS IN ADDITION TO AND DOES NOT AFFECT YOUR RIGHTS UNDER THE CONSUMER GUARANTEES ACT.

Procedure for obtaining performance or warranty: In the event that the Product does not conform to this warranty, the Product should be shipped or delivered, freight prepaid, with evidence of original purchase, (eg. a copy of the sales docket), to the warrantor at:

UNIDEN AUSTRALIA PTY LTD
Service Division
345 Princes Highway,
Rockdale, NSW 2216
Fax (02) 9599 3278
www.uniden.com.au

UNIDEN NEW ZEALAND LTD
Service Division
150 Harris Road, East Tamaki,
Auckland
Fax (09) 274 4253
www.uniden.co.nz

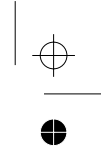
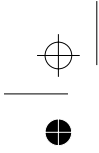

Uniden®

© 2005 Uniden Australia Pty Limited/Uniden New Zealand Limited
Printed in China UTZZ01898AA(0)

